



Neutron Induced Nuclear Counter Effect in Hamamatsu Silicon APDs and PIN Diodes

Rihua Mao, Liyuan Zhang, Ren-yuan Zhu

California Institute of Technology



Introduction

- Because of its immunity to magnetic fields silicon based readout device is widely used in HEP calorimeters. They are often located in particle showers, where neutrons are produced copiously. While the nuclear counter effect caused by charged particles is well understood, it is less known for neutrons.
- Hamamatsu silicon devices tested:
 - A pair of S8664-55 APD: $2 \times 5 \times 5 \text{ mm}^2$ (connected in parallel)
 - An S2744-08 PIN diode: $1 \times 2 \text{ cm}^2$
- Neutron sources: ^{252}Cf and $^{241}\text{Am-Be}$.
- γ -ray sources: ^{55}Fe , ^{241}Am , ^{57}Co and ^{60}Co .

252Cf Measurement Set-up

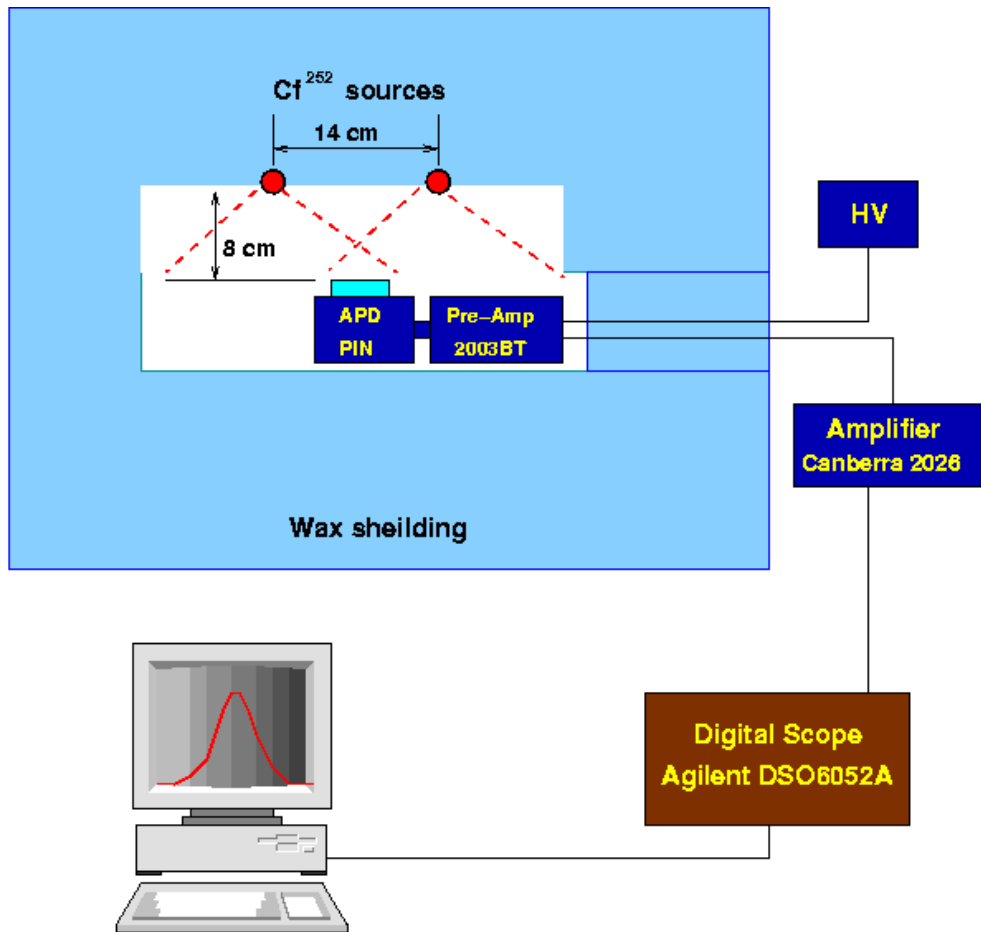

Neutron flux at the device surface:
 $1.4 \times 10^4 \text{ n/cm}^2/\text{s}$, calculated with calibrated mass ($2.3 \times 10^4 \text{ n/s}/\mu\text{g}$), geometrical distance, and time since delivery ($\tau_{1/2}=2.6 \text{ yr}$).

The PIN was biased at **70 V**.
 The APDs were biased for gains of **1, 10, 35, 100 and 200**.

Readout

Preamplifier: Canberra 2003 BT
 Shaping amplifier: Canberra 2026 with $0.25 \mu\text{s}$ shaping time,
 Digital scope: Agilent 6052A.

The ^{241}Am -Be, ^{241}Am and ^{60}Co Setup

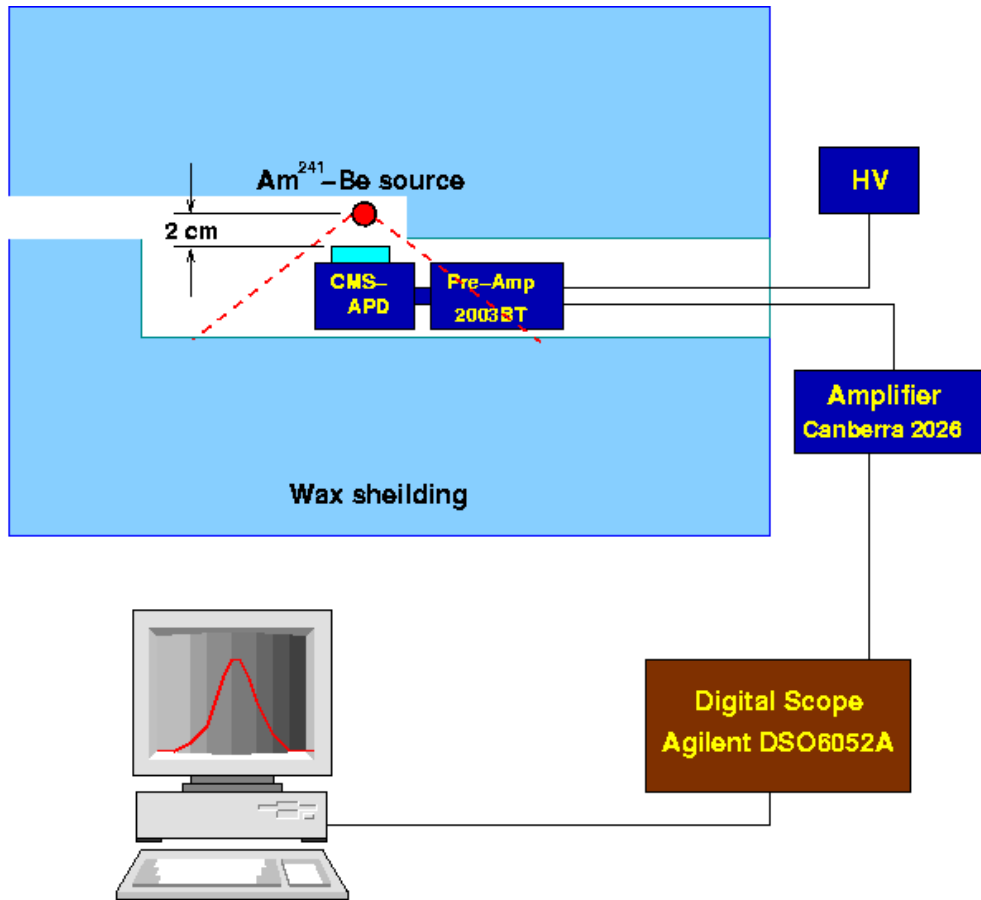

Am²⁴¹-Be Neutron flux:
 $6.0 \times 10^4 \text{ n/cm}^2/\text{s}$ at the device surface, calculated with the calibration (NIST 846/257817-93), distance, and time ($\tau_{1/2}=432.2 \text{ yr}$).

The readout is the same as that for the ^{252}Cf source.

A similar set-up was used to carry out tests with gamma-ray and x-ray sources:

^{241}Am : $1.06 \times 10^7 \text{ } \gamma/\text{cm}^2/\text{s}$.

^{60}Co : $1.54 \times 10^6 \text{ } \gamma/\text{cm}^2/\text{s}$.

E_{Neutron} from $^{241}\text{Am-Be}$ and ^{252}Cf Sources

- Neutrons from $^{241}\text{Am-Be}$ source has a broad distribution from 1 to 10 MeV with an average energy of 4.5 MeV.
- With a range of 1-10 MeV, the energy of neutrons from ^{252}Cf source is peaked at 2.2 MeV.

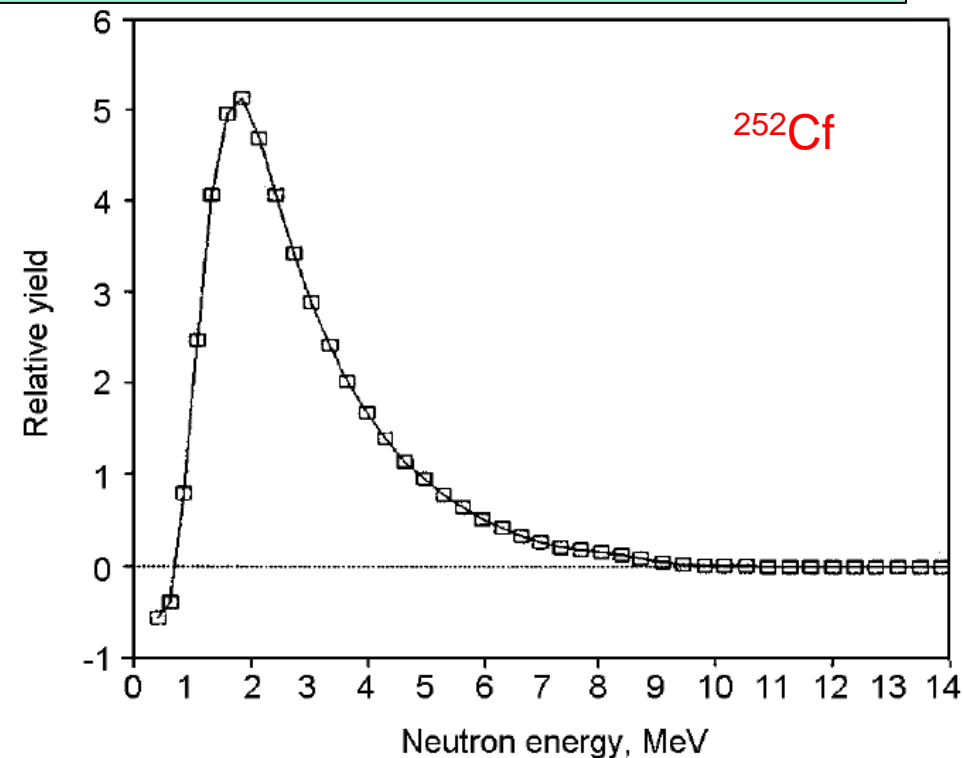
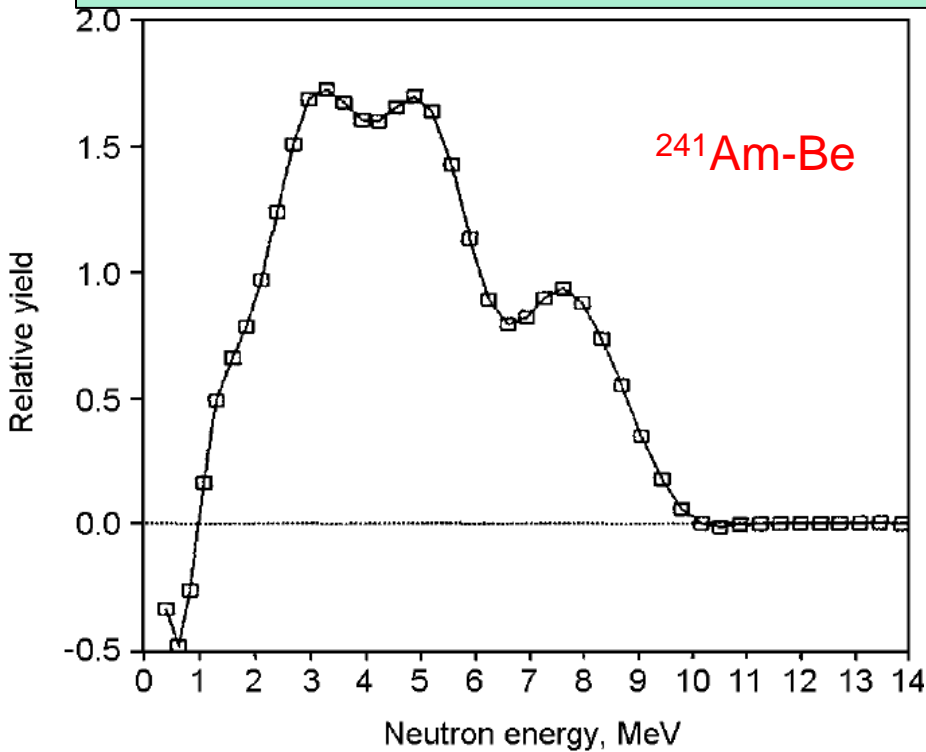

S.-T. Park, J. Rad. & Nucl. Chem., Vol 256 (2003) 163

Calibration Set-up

- The p.e. in PIN was calibrated with ^{241}Am and ^{57}Co .
- The APD gain was measured with blue LED.
- The p.e. in APD was calibrated with ^{55}Fe .

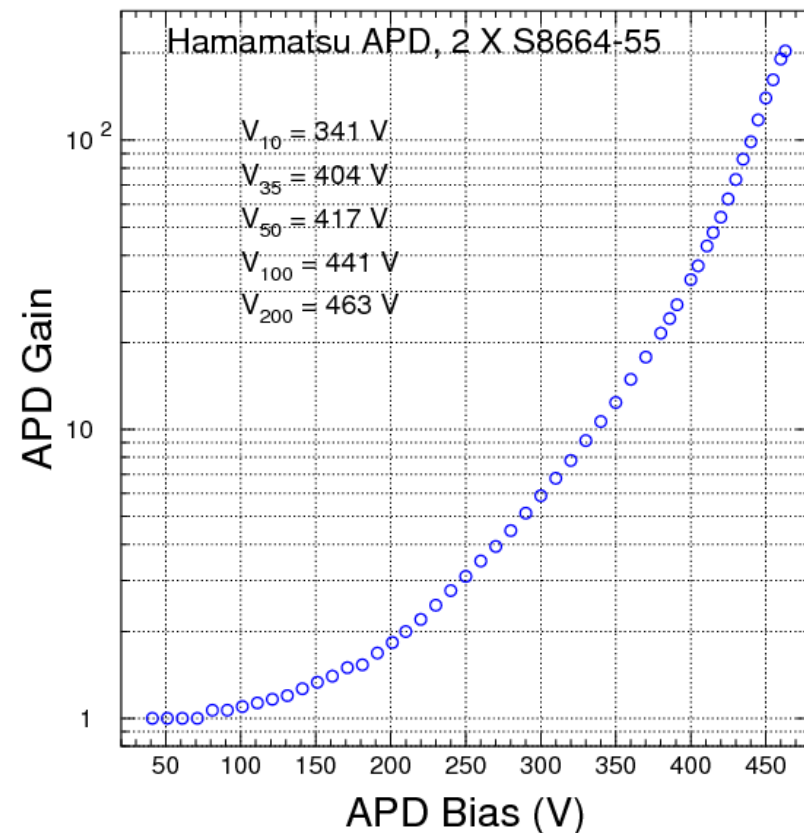
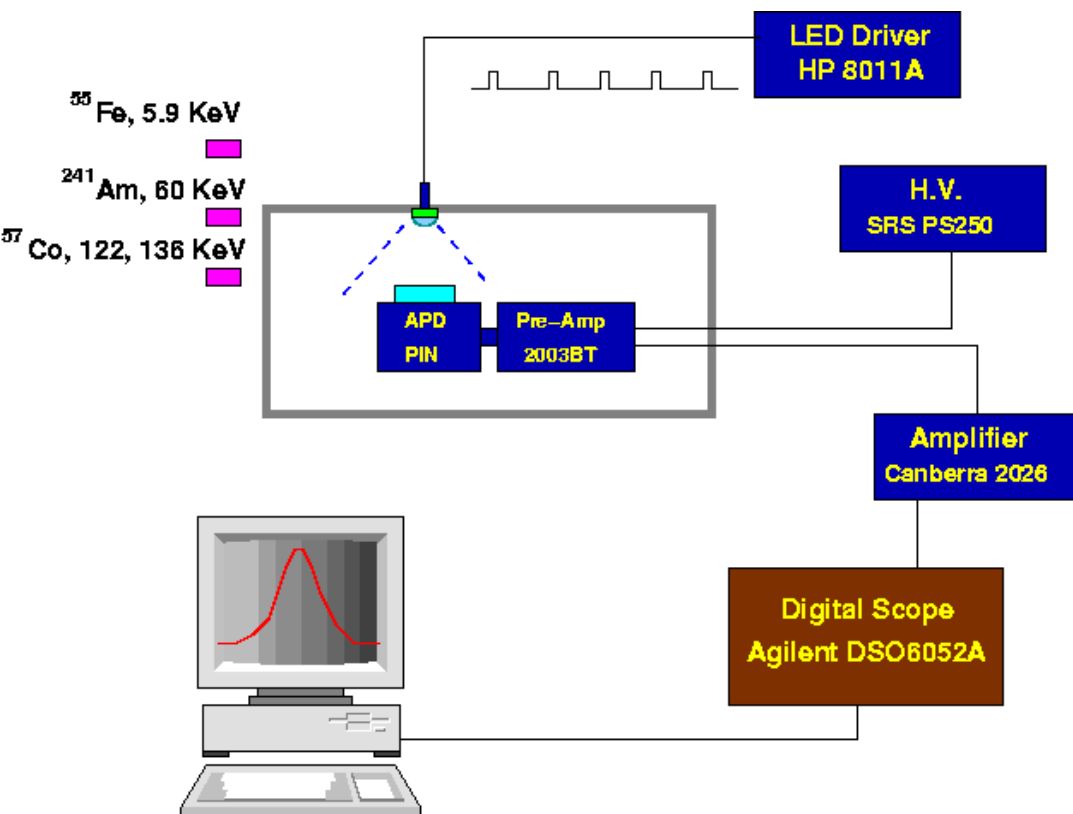

S2744-08 PIN Diode Calibration

- Pulse height spectra were measured with X-rays from ^{241}Am (60 KeV) and ^{57}Co (122, 136 KeV) sources.
- The system noise is calculated by using the pedestal width.

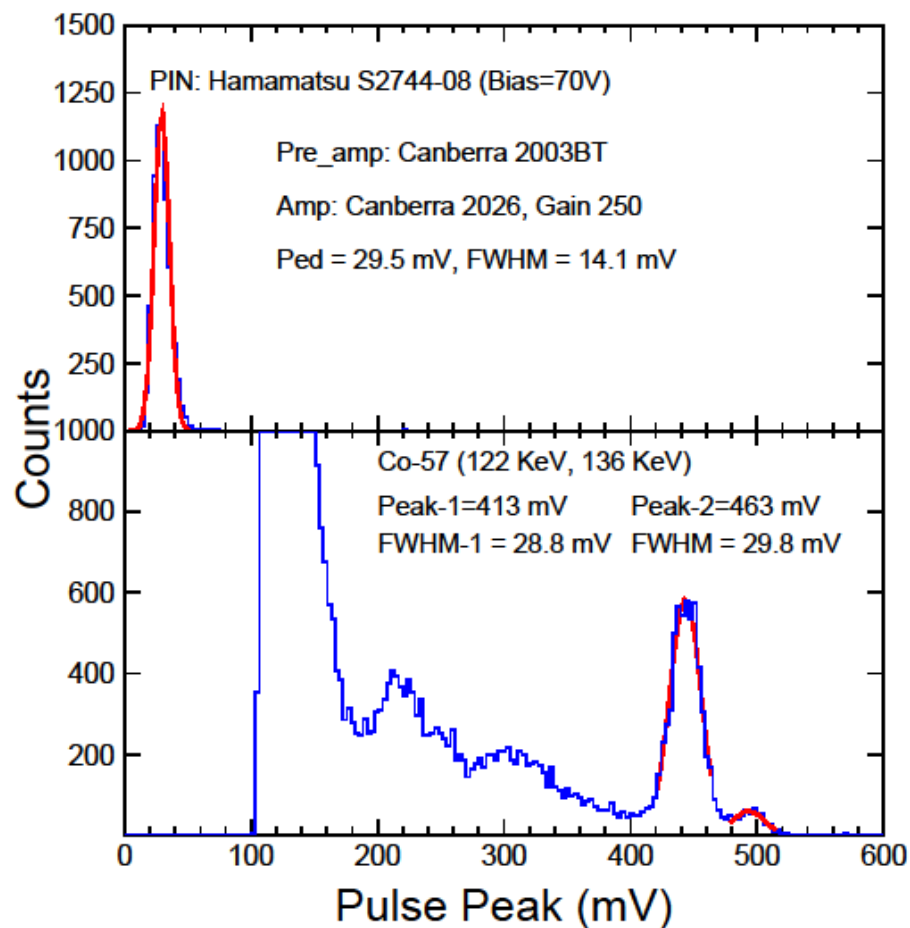
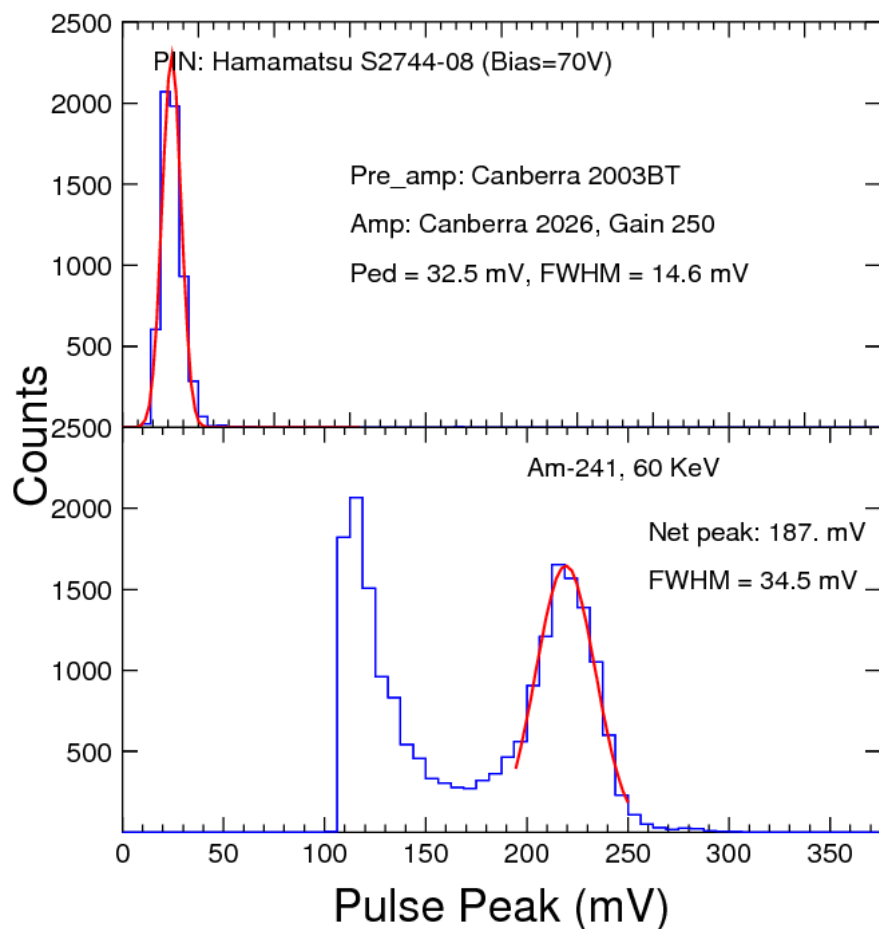

S2744-08 PIN Diode Calibration

Consistent calibration for electron numbers in PIN was obtained using ^{241}Am and ^{57}Co sources.

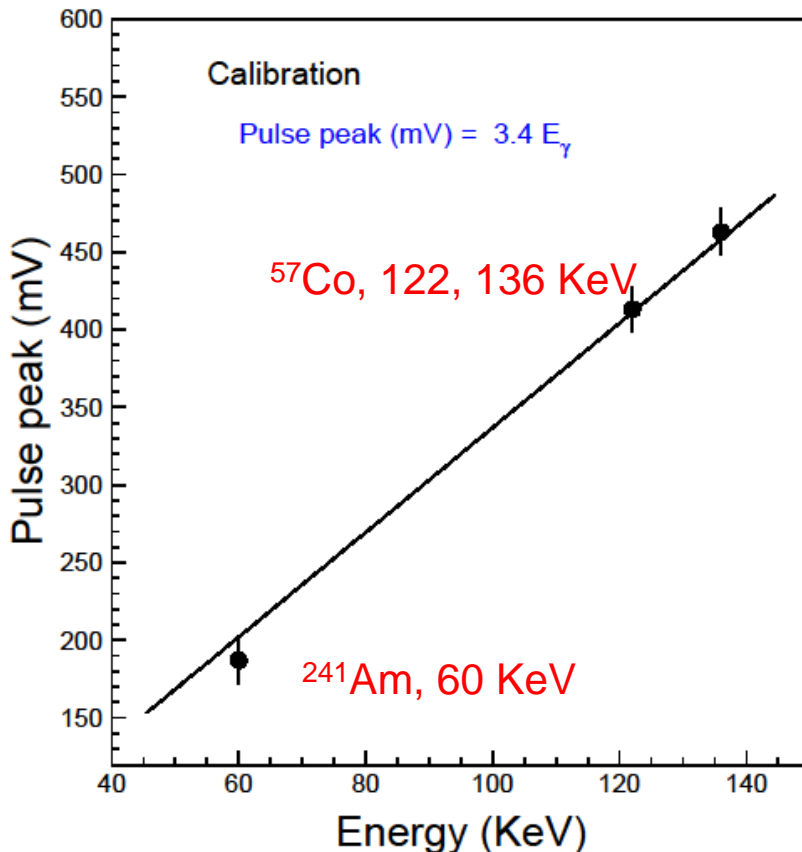

The p.e. calibration for PIN diode:

$$N_e/V = \frac{E_{x\text{-ray}}/3.62}{P_{x\text{-ray}}} \cdot \frac{G_{x\text{-ray}}}{G_n}$$

N_e/V : equivalent p.e. number/ peak volt,

$E_{x\text{-ray}}$: x-ray energy in eV,

$P_{x\text{-ray}}$: measured PH peak of x-ray,

$G_{x\text{-ray}}$: shaping amplifier gain for the x-ray sources,

G_n : shaping amplifier gain for the neutron sources,

S8664-55 APD Calibration with ^{55}Fe (I)

APD gain was set at 10 and 35

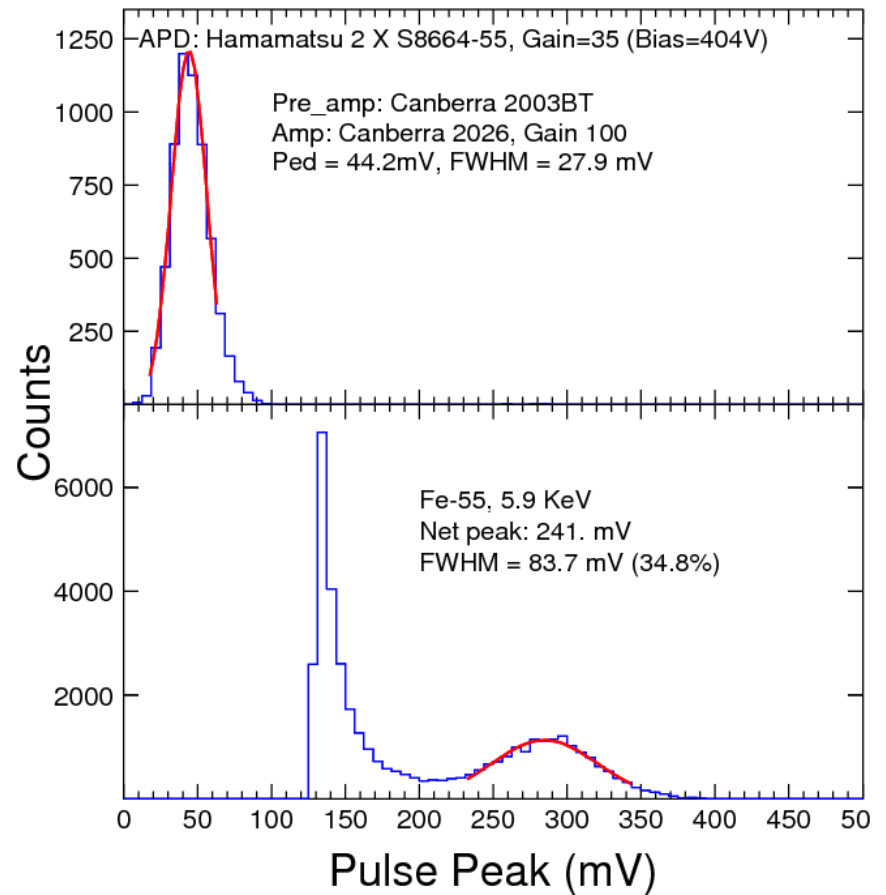
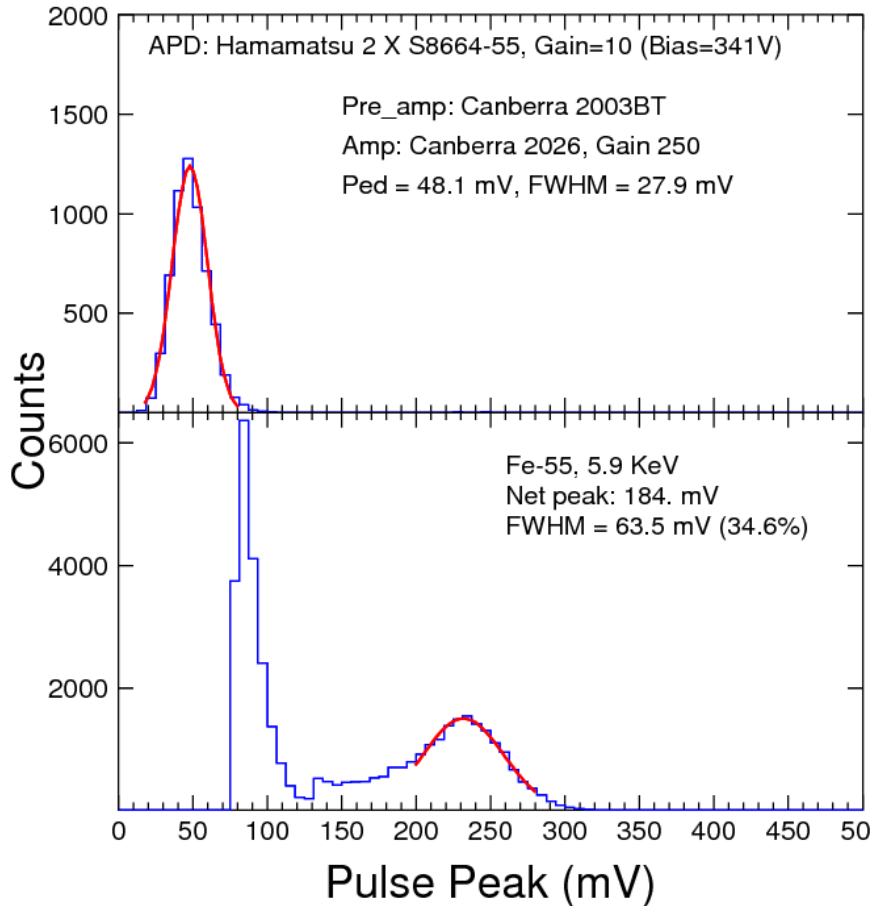

S8664-55 APD Calibration with ^{55}Fe (II)

APD gain was set at 100 and 200

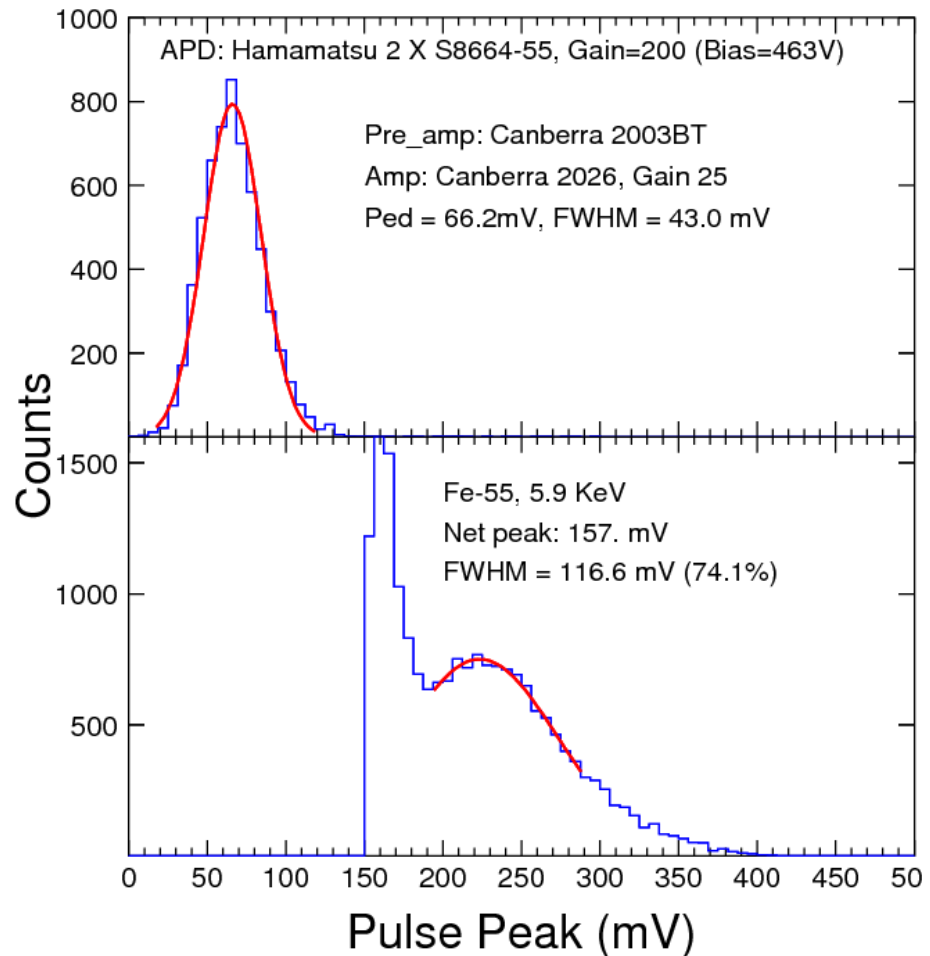
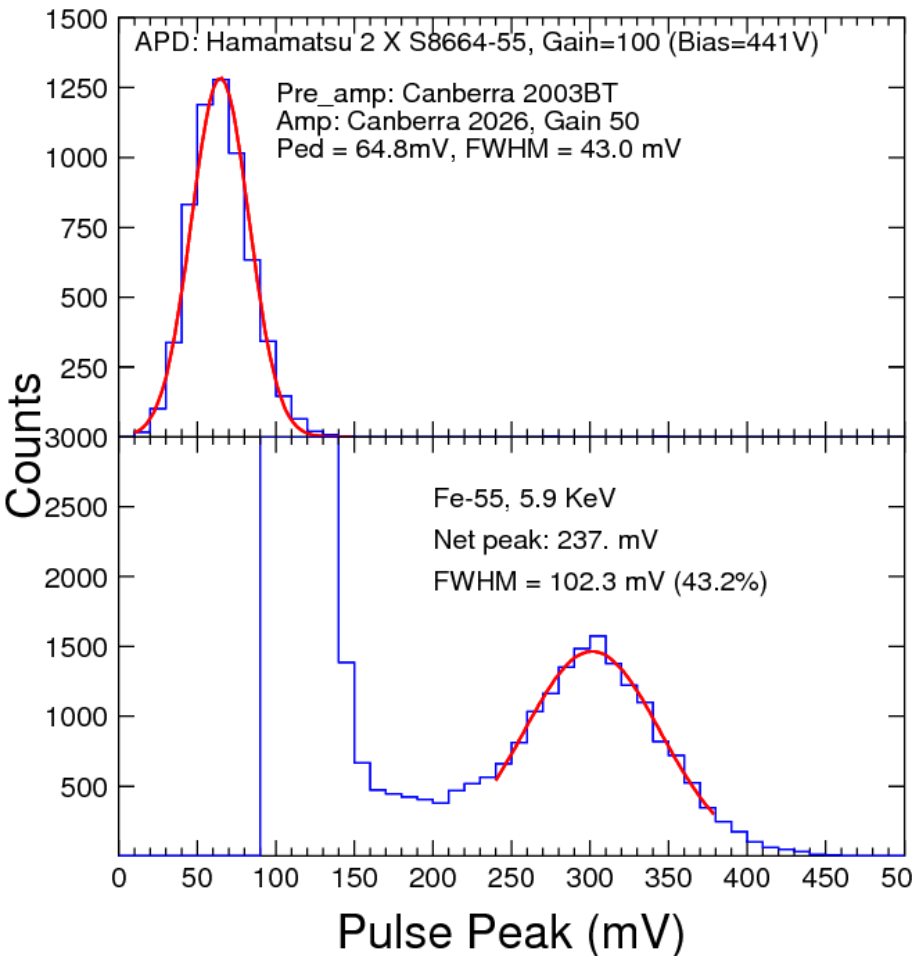

$^{55}\text{Fe}/\text{LED}$ Corrections and APD Calibration

Large correction factors are noticed for high APD gains, which are consistent with published data in J. Chen *et al*, *IEEE Trans. Nucl. Sci.* Vol 54 (2007) 718.

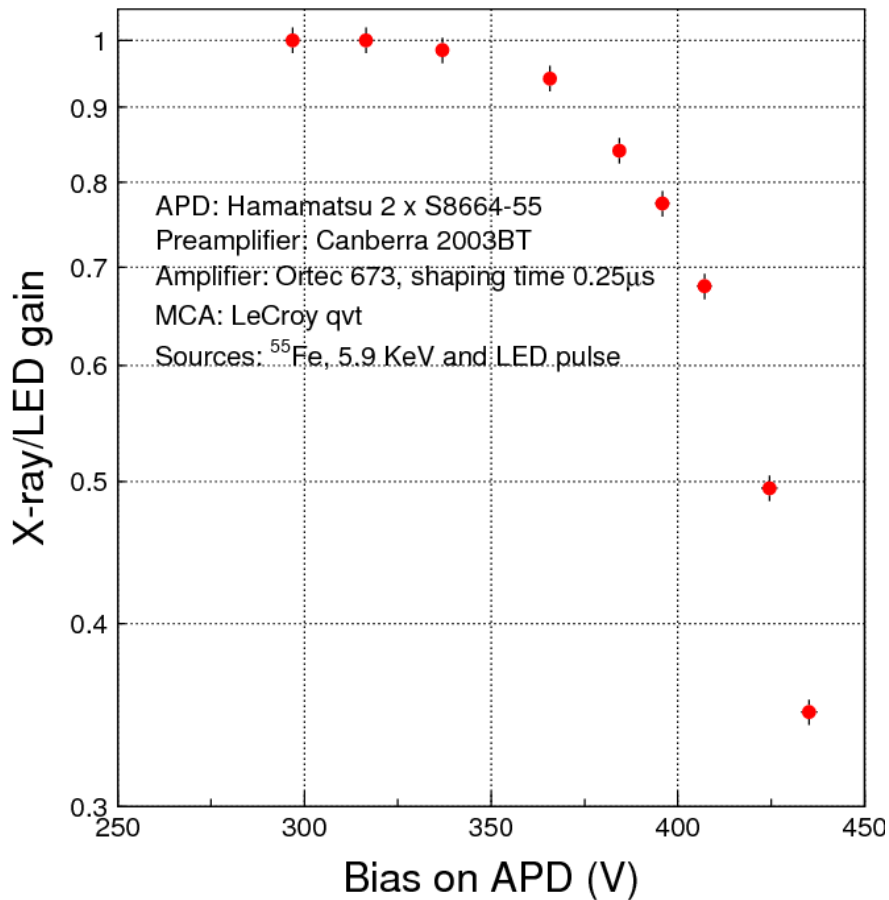

The calibration with ^{55}Fe , 5.9 KeV for APD at a certain bias:

$$N_e/V = \frac{E_{x\text{-ray}}/3.62 \times R_{x\text{-ray}/\text{LED}} \cdot G_{x\text{-ray}}}{P_{x\text{-ray}}} \cdot \frac{G_{x\text{-ray}}}{G_n}$$

N_e/V : equivalent p.e. number/ volt,

$E_{x\text{-ray}}$: 5900 eV,

$P_{x\text{-ray}}$: measured PH peak,

$R_{x\text{-ray}/\text{LED}}$: Correction factors for x-rays,

$G_{x\text{-ray}}$: shaping amplifier gain for the x-ray source,

G_n : shaping amplifier gain for the neutron sources,

Calibration Summary

	PIN S2744-08	APD S8664-55				
Bias (V)	70	341	404	417	441	463
Device Gain	1	10	35	50	100	200
$G_{x\text{-ray}}$	250	250	100	50	50	25
G_n	50	2.5	2.5	2.5	2.5	2.5
N_e/V ($\times 10^3$)	812	438	212	144	66.7	35.8
$\sigma_n (N_e)$	498	104	70	66	78	77

^{252}Cf Spectra for APD @ Gain 35

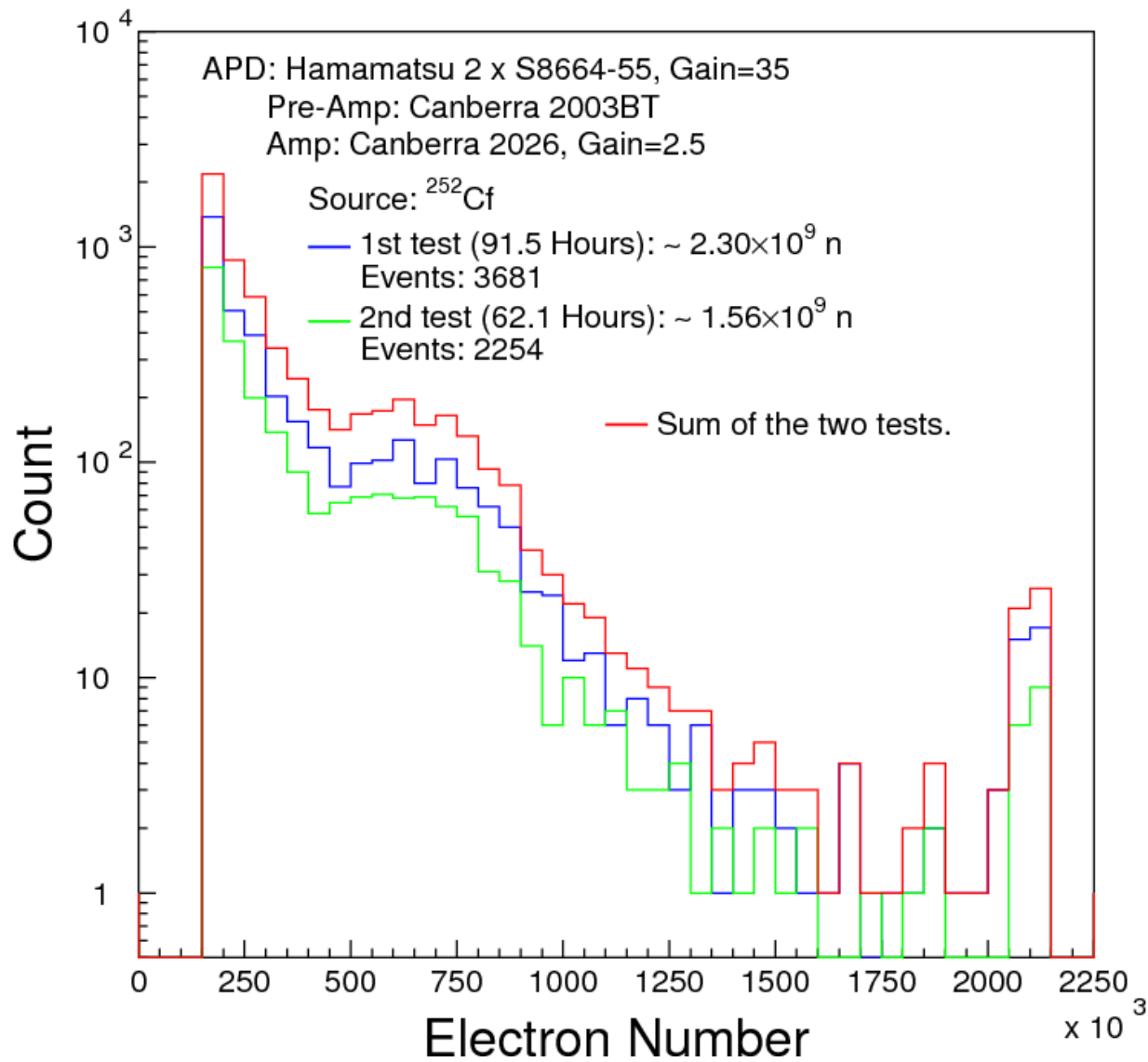

➤ The up-limit of the pulse height distribution is ~ 2 M electrons, or 7.2 MeV deposition in APD.

➤ There are a few tens overflow events caused by the saturated amplifier scale, indicating energy deposition of higher than 7.2 MeV.

^{252}Cf Spectra for APD at different Gains

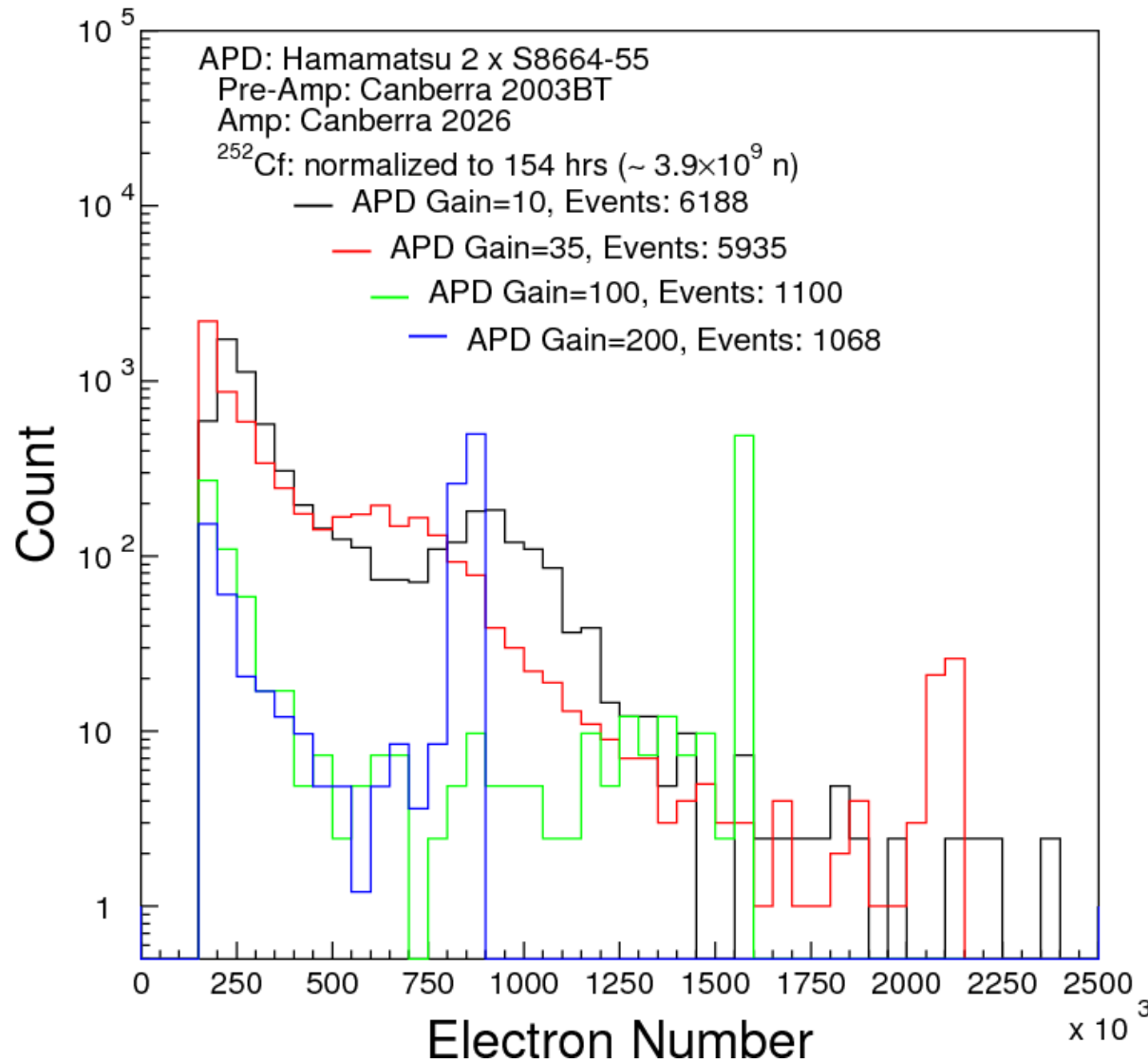

The amplifier saturation was more significant for the APD gains of 100 and 200.

The fractions of events with signals of more than 150 k electrons (0.5 MeV deposition) are:

$$1.6 \times 10^{-6}, G=10$$

$$1.5 \times 10^{-6}, G=35$$

$$0.28 \times 10^{-6}, G=100$$

$$0.27 \times 10^{-6}, G=200,$$

indicating that a high APD gain reduces the neutron-induced nuclear counter effect in the APD.

Comparison between APD and PIN

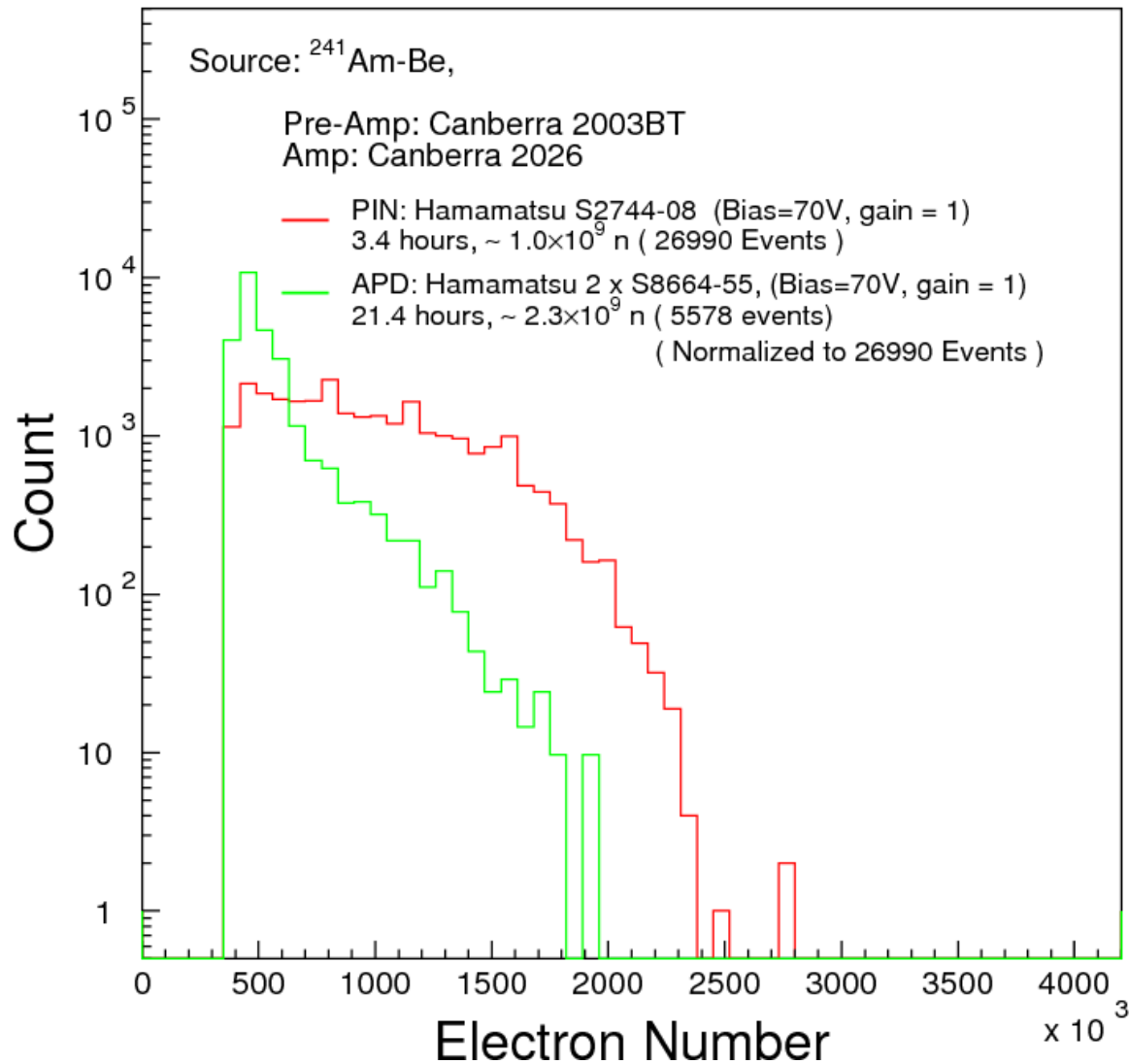

Signals of up to 2.5 and 2 M electrons were observed in the PIN and APD with unit gain respectively, corresponding to 9 and 7.2 MeV energy deposition.

The fractions of events with signals of more than 350 k electrons (1.3 MeV deposition) are:

PIN: 27×10^{-6} ,
APD (G=1): 2.4×10^{-6} ,
 indicating that the neutron-induced nuclear counter effect in the APD is a factor of ten smaller than that in the PIN diode.

^{252}Cf Spectra for PIN with Materials

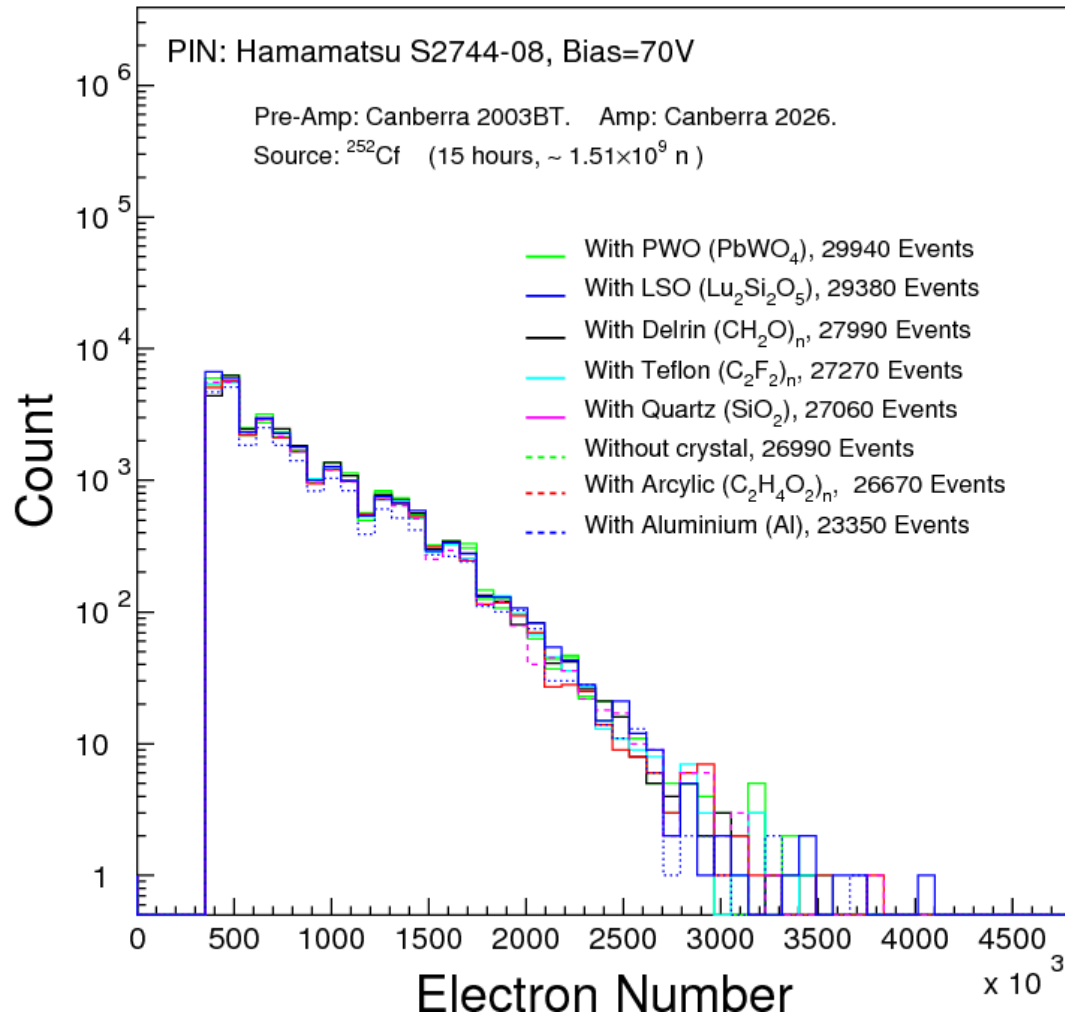

- 1 to 2 cm thick materials were inserted at the front of the PIN.
- The overall effect of materials at the front of the PIN diode is small, indicating that the nuclear counter effect is dominated by the detector itself.
- High Z material, such PWO and LSO, enhances a little the effect, while the low Z material, such as H, C, O and Al, reduces a little the effect.

- The γ -ray background from ^{60}Co and ^{241}Am sources was checked using orders of magnitude high fluence. The spectra show no high tail.
- No event was recorded when APD and PIN diode was replaced by a 100 pf capacitor, indicating no background from the readout system.

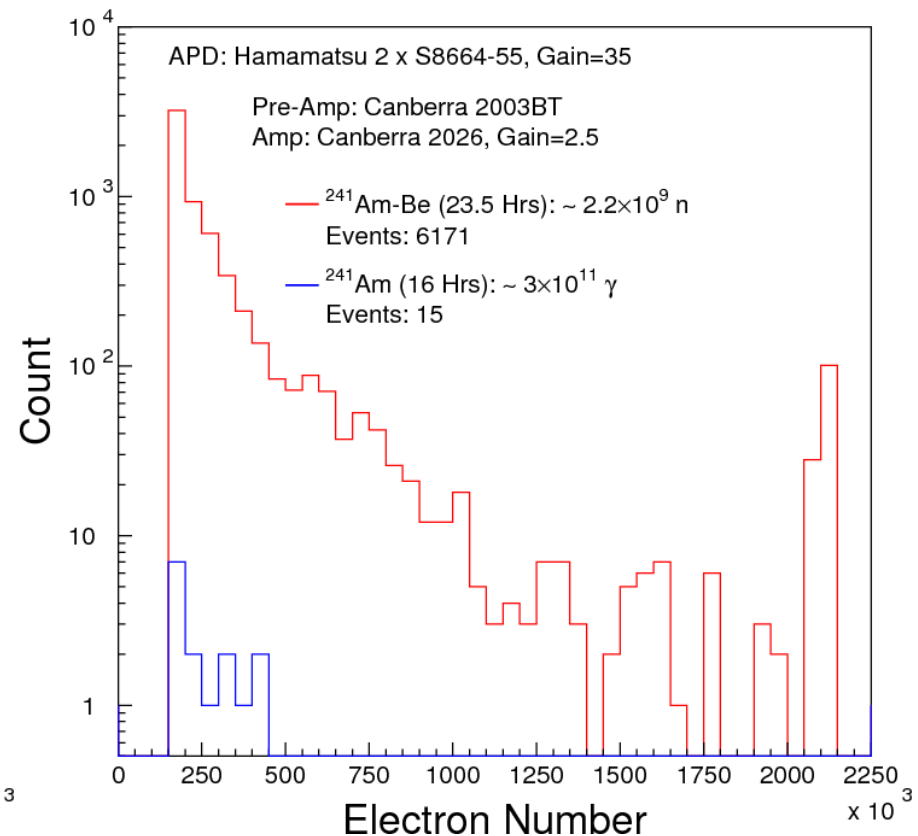
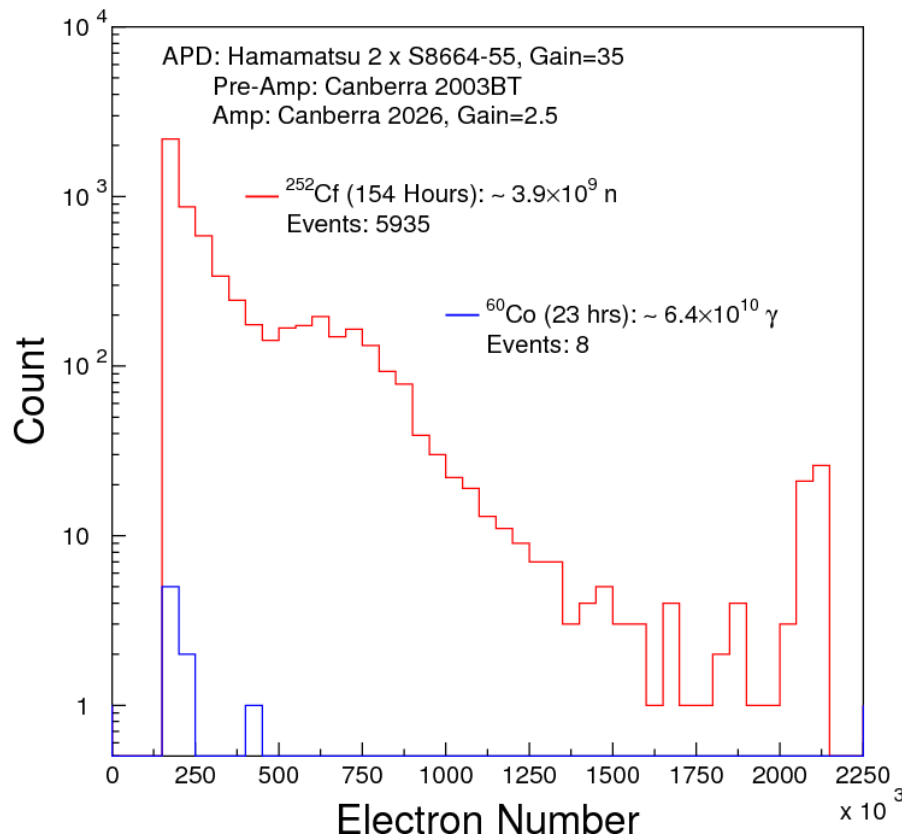

Approaches to Eliminate this Effect

- Multiple independent readout channels for one crystal would be a good solution. The potential high cost may be minimized by an intelligent frontend chip (IFC) which reads out only uncontaminated signals.

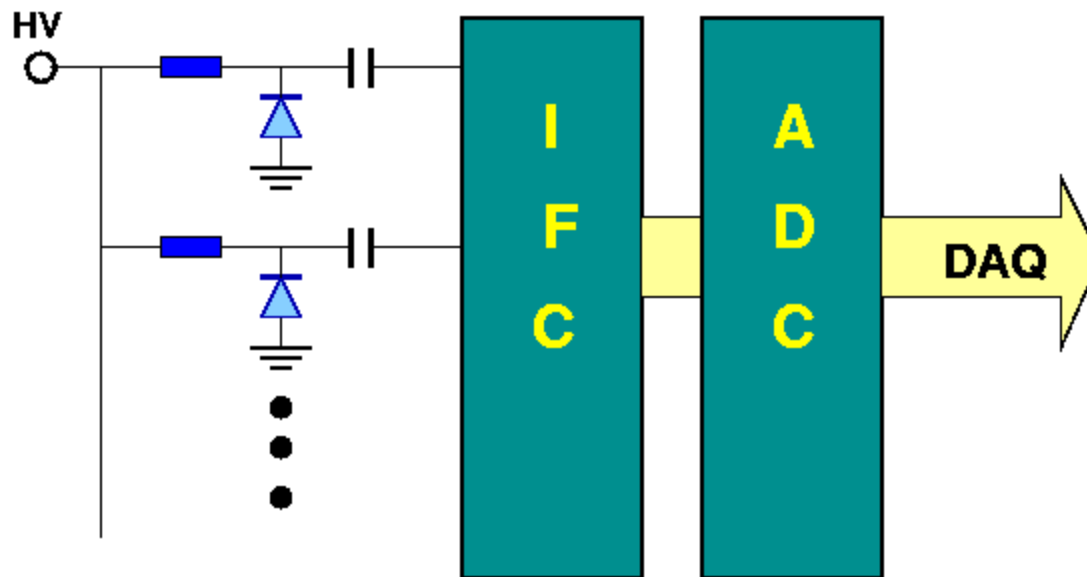

- Advanced data analysis may also be implemented to reduce this effect as discussed in CMS Note 2010-12:

<http://cdsweb.cern.ch/record/1278160?ln=en>

Summary

MeV neutrons from ^{252}Cf and $^{241}\text{Am-Be}$ sources cause signals up to a few million electrons, or ~ 10 MeV energy deposition, in Si APD and PIN diode, indicating that the entire kinetic energy of a neutron may be converted into electron signals in these devices.

The equivalent energy of calorimeter readout depends on the crystal light yield. Anomalous signals of 2 M electrons, for example, correspond to 500 and 2.5 GeV for PWO and LYSO respectively assuming the light yields of 4 and 800 p.e./MeV for long crystals.

The overall effect in APD is a factor of ten less than PIN diode. Increasing the APD gain reduces the effect since only a portion of the energy in APD is fully amplified as the scintillation photoelectrons.

Multiple photo-devices with independent readout chains would eliminate this effect completely. An intelligent front-end chip capable of selecting un-contaminated signal will keep the total channel counting under control. The neutron induced nuclear counter effect may also be reduced by advanced data analysis.

Relevant paper of PIN

“Fast neutron detector using PIN-type silicon photodiode”
 Y. Hosono et. al, NIM, A361, p554,1995

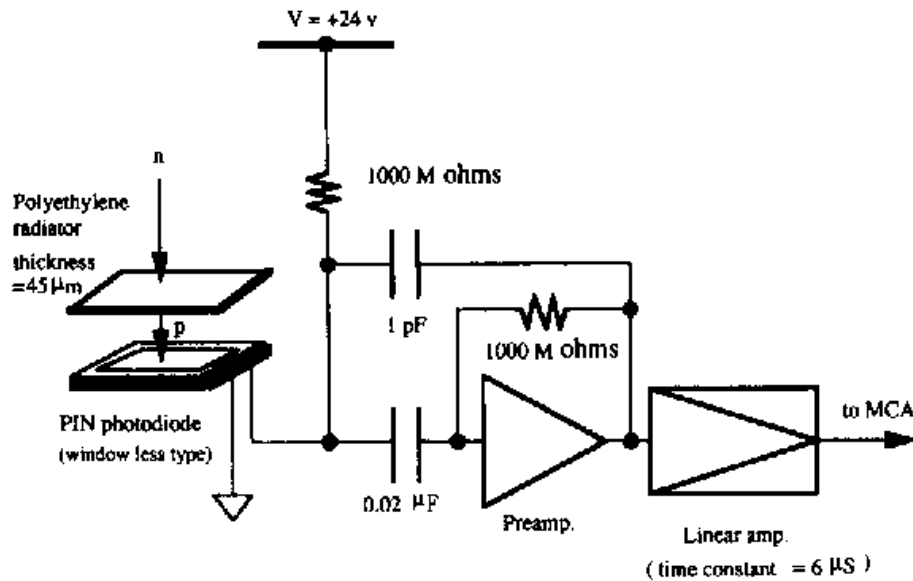
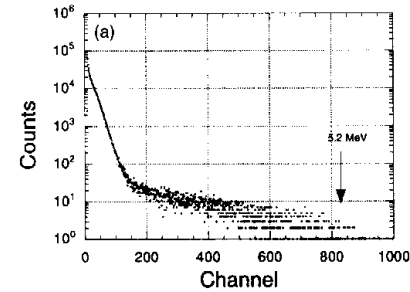

Fig. 1. Block diagram of the fast neutron PD detector.



Fraction = 7.8×10^{-5}

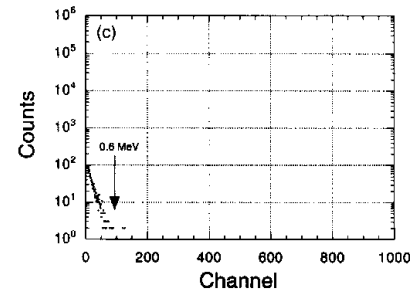
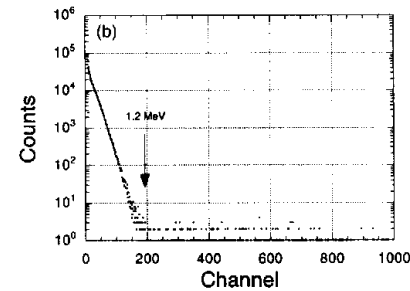

Fig. 3. Pulse height distribution for ^{252}Cf neutrons. (a) with a polyethylene radiator (thickness = $45 \mu\text{m}$). (b) without polyethylene radiator. (c) background in case of no neutron source.